



WS No. 19 Mark III

**This file has been down loaded from  
The Wireless-Set-No19 WEB site.**

**All files from this WEB site are free of charge.  
If you have been charged for this file then please  
contact the person you obtained it from as he/she  
has illegally obtained both the file and money they have  
charged you.....**

H I

*Crown Copyright Reserved*

PW H1

# Post Office Engineering Department

## TECHNICAL PAMPHLETS FOR WORKMEN

*Subject*

### OPEN LINE CONSTRUCTION PART I

ENGINEER-IN-CHIEF'S OFFICE,  
1919.

*(Reissued 1924. Reprinted Feb. 1927, incorporating amendment to date.)*

*(Reprinted May, 1929, incorporating amendments to date.)*

{	..	Feb., 1931,	..	..	..	..	}
{	..	July, 1932,	..	..	..	..	}
{	..	Oct., 1934,	..	..	..	..	}

LONDON

PUBLISHED BY HIS MAJESTY'S STATIONERY OFFICE

To be purchased directly from H.M. STATIONERY OFFICE at the following addresses:  
Admiral House, Kingway, London, W.C.2; 130 George Street, Edinburgh 3;  
25 York Street, Manchester 1; 1 St. Andrew's Crescent, Cardiff;  
50 Chichester Street, Belfast;  
or through any bookseller

1937

Price 6d. net

# LIST OF Technical Pamphlets for Workmen

---

---

## GROUP A.

1. Magnetism and Electricity.
2. Primary Batteries.
3. Technical Terms.
4. Test Boards.
5. Protective Fittings.
6. Measuring and Testing Instruments.
7. Sensitivity of Apparatus.
8. Terms and Definitions used in Telegraphy and Telephony.

## GROUP B.

1. Elementary Principles of Telegraphy and Systems up to Morse Duplex.
2. Telegraph Concentrators.
3. Wheatstone. Morse Keyboard Perforators.
4. Quadruplex. Telegraph Repeaters, Sx., Dx., and Quad.
5. Hughes Type-printing Telegraph.
6. Baudot Multiplex.
7. Western Electric Multiplex. Murray Multiplex. Other Systems.
8. Fire Alarm Systems.

## GROUP C.

1. Wireless Transmission and Reception.
2. Interference with Reception of Broadcasting.

## GROUP D.

1. Elementary Principles of Telephony.
2. Telephone Transmission. "Loading." Telephone Repeaters and Thermionic Valves.
3. Principles of Telephone Exchange Signalling.
4. Magneto Exchanges—Non-Multiple Type.
5. Magneto Exchanges—Multiple Type.
6. C.B.S. No. 1 Exchanges—Non-Multiple Type.
7. C.B.S. Exchanges—Multiple Type.
8. C.B. Exchanges—No. 9 Type.
9. C.B. Exchanges—No. 10 Type.
10. C.B. Exchanges—No. 12 Type.
11. C.B. Exchanges—22 Volts.
12. C.B. Exchanges—40 Volts.
13. Trunk Telephone Exchanges.
14. Maintenance of Manual Telephone Exchanges.
15. Telephone Testing Equipment.
16. Routine Testing for Manual Telephone Exchanges.
17. Internal Cabling and Wiring.
18. Distribution Cases, M.D.F. and I.D.F.
19. Cord Repairs.
20. Superposed Circuits, Transformers, etc.
21. Call Offices.

[Continued on page iv. of Cover.]

**CORRECTION SLIP TABLE**

---

The month and year of issue is printed at the end of each amendment in the Correction Slips, and the number of the slip in which any particular amendment is issued can, therefore, be traced from the date. In the case of short corrections made in manuscript, the date of issue of the slip should be noted against the correction.

The Summary portions of the Correction Slips should be completed and affixed below in numerical order.

---

**CORRECTION SLIP TABLE (contd.)**

---

The month and year of issue is printed at the end of each amendment in the Correction Slips, and the number of the slip in which any particular amendment is issued can, therefore, be traced from the date. In the case of short corrections made in manuscript, the date of issue of the slip should be noted against the correction.

The Summary portions of the Correction Slips should be completed and affixed below in numerical order.

---

# OPEN LINE CONSTRUCTION

## PART I

(H1)

---

*The following pamphlets in this series are of kindred interest :*

- H2 Open Line Construction (Part II)
- H3 Open Line Maintenance
- H8 Power Circuit Guarding

---

### TABLE OF CONTENTS.

	PAGE
1. POLES .. .. .	5
2. FITTING OF POLES .. .. .	8
3. POLE HOLES .. .. .	10
4. ERECTION OF POLES .. .. .	11
5. STAYS .. .. .	14
6. STRUTS .. .. .	19
7. ARMS.. .. .	19
8. INSULATORS .. .. .	20
9. SUBSCRIBERS' OVERHEAD DISTRIBUTION .. .. .	20
10. SPECIAL LIGHT CONSTRUCTION FOR SUBSCRIBERS' AND JUNCTION LINES .. .. .	25
APPENDIX A. ARMS .. .. .	26
APPENDIX B. INSULATORS .. .. .	27
APPENDIX C. SPINDLES .. .. .	28



## FOR OFFICIAL USE

## OPEN LINE CONSTRUCTION

## PART I

## 1.—POLES.

**Types.**—The following types of poles are in use :—

(i) **Creosoted wooden poles.**—These fall into three classes, light, medium, and stout, the respective lengths of each class in general use being 16 feet to 50 feet, 24 feet to 65 feet, and 28 feet to 85 feet.

(ii) **Burnettized wooden poles.**—These poles are treated by a special preservative process which renders them more suitable for painting, as is frequently demanded in residential districts. They are now no longer supplied, as improvements have been made in the creosoting process which allows creosoted poles to be painted.

(iii) **Iron poles.**—These have been used in good-class residential districts for which ornamental poles were stipulated by the Local Road Authorities.

**Single, “ A ” and “ H ” Poles.**—The normal practice is to use single poles carrying arms for four, six or eight wires. For heavy lines “ A ” poles are inserted at intervals. These consist of two single poles scarfed together as shown in Fig. 1. “ A ” poles are also inserted in lines of single poles at intervals in exposed positions where it is desired to increase the lateral stability of the line.

“ H ” poles were formerly used with six-way arms for heavy trunk lines. They consist of two single poles braced together as shown in Fig. 2. They are now rarely used as they are expensive, and the use of underground lines is usually preferable.

**Strength.**—Allowing for the effect of wind pressure on the poles at the rate of 17 lbs. per square foot on a projected flat surface, which corresponds to a wind of 80 miles an hour, the safe loads for the various classes of poles, allowing a factor of safety of 4, are as follows :—

Light Poles	..	..	..	160 lbs.
Medium Poles	..	..	..	320 lbs.
Stout Poles	..	..	..	640 lbs.

These loads are assumed to be applied at a point two feet from the top of the pole, the pole being buried five feet in the ground.



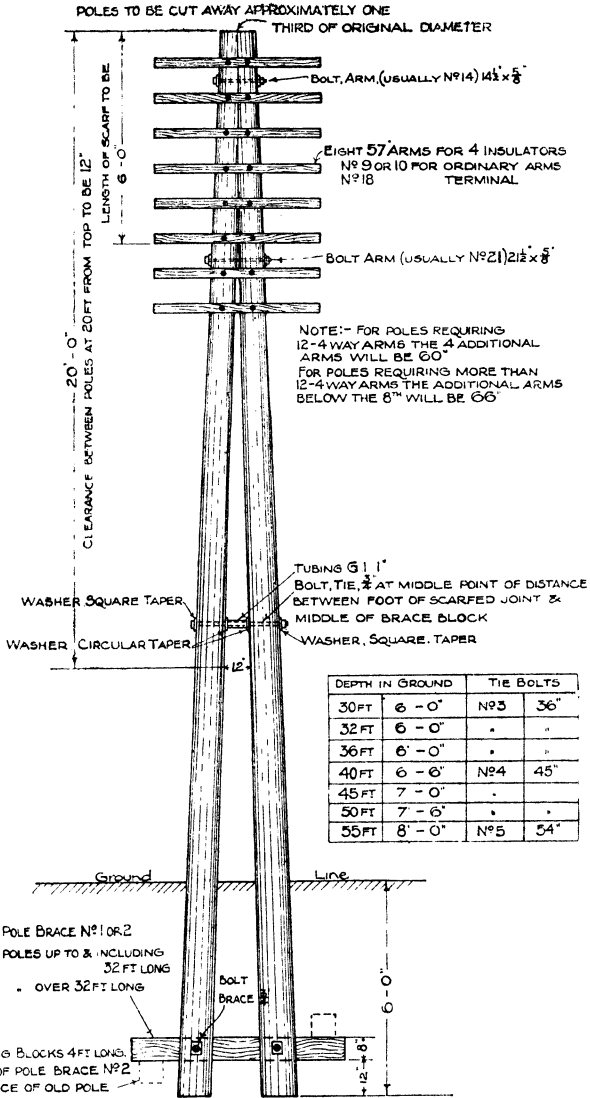

METHOD OF CONSTRUCTING A POLES (STOUT)

Fig. 1.

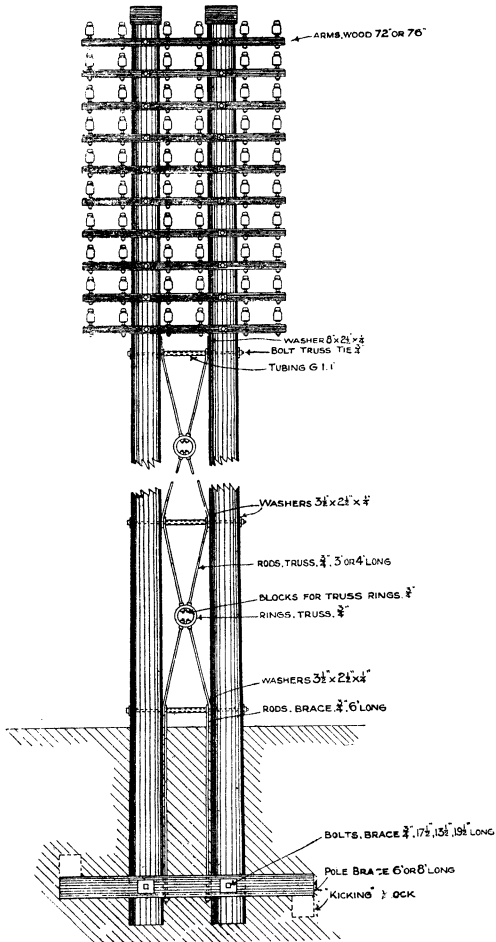

Fig. 2.

It may be taken that in practice tensions due to angles in the lines are taken by stays; and since in straight lines the line wires exercise no pull on the poles, the safe load of the pole indicated on page 5 is all available to counteract the effect of wind pressure on the line wires.

For a span of 65 yards, the wind pressure on one wire, with a gale of 80 miles an hour, is given below.

Copper.		Bronze.	
Gauge.	Wind pressure.	Gauge.	Wind pressure.
lbs. per mile.	lbs.	lbs. per mile.	lbs.
100	22·2	40	13·1
150	28·0	70	17·9
200	32·9		
300	41·1		
400	48·0	200	35·8
600	59·3	400	51·9

The total pressure on a bay of wires is obtained by multiplying these figures by the number of wires.

For different lengths of span, the pressures are proportional to the length of the span.

Lines in sheltered localities, such as streets, do not feel the full effect of storms; consequently a much greater number of wires may be carried by a pole than is indicated above.

## 2.—FITTING OF POLES.

**Arms** are fitted to poles in such a manner that should a pole be slightly bent, the stress exerted by the line wires when in position will tend to straighten the pole. (See also page 19.)

**Finials.**—These are fitted to the tops of poles in residential neighbourhoods where it is desired to render the pole as ornamental as possible.

**Pole Roofs.**—When finials are not used, galvanized iron pole roofs are fitted to prevent moisture from entering the pole through the exposed pores. This would tend to shorten the life of the pole. Roofs are fitted transversely to the line of the wires, and are held in position by four two-inch rosehead nails.

**Saddles.**—It is sometimes required to run one or two wires on the top of the pole. Galvanized iron saddles are provided for this purpose and fitted with ordinary spindles for single wires and with spindles No. 13 for two wires.

At angles where the saddles would be subjected to heavy stresses, saddle stays consisting of G.I. hoop, packed with hard wood wedges, are used to reinforce the saddle.

**Pole Steps.**—Steps are fitted on alternate sides of poles at a vertical distance of 15 inches apart in order to facilitate climbing. In general the lowest step should be not less than 24 feet from the ground. Light poles carrying one arm, pole brackets, or a cap wire only, are fitted with two pole steps in order to facilitate work on the pole.

**Earth Wiring.**—Poles are fitted with a 150 lb. copper H.D earth wire, to act as a lightning conductor :—

- (1) On every tenth pole on main lines ;
- (2) On all distribution poles ;
- (3) On all poles in exposed situations, subject to lightning storms

and also, to prevent leakage interference, on all poles on lines which carry single wire telegraph circuits. The method of fitting is shown in Fig. 3. The pole earth wire is secured by copper staples 1 in.

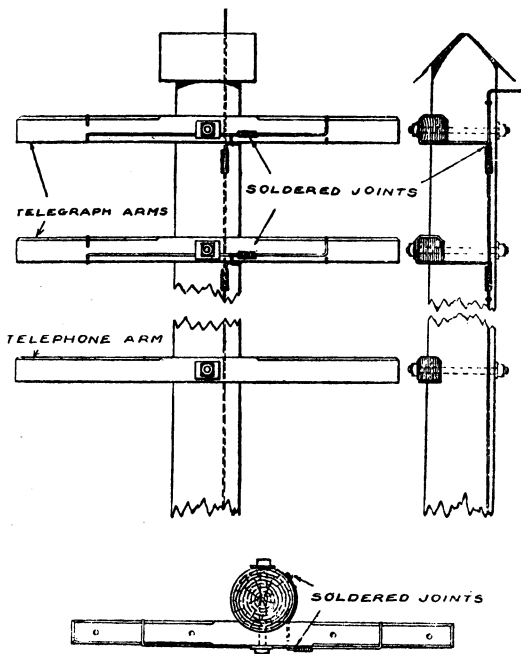

Fig. 3.

**Cutting of Poles.**—Examination of poles found to have decayed in service often shows that decay has started at a point where the outer layers of impregnated wood have been removed when fitting Arms, Pole Roofs and Struts or in the scarfing of A-poles. Whenever any of the uncreosoted parts of a pole are exposed in this way, the exposed surface should be liberally treated with a mixture of "Creosote and Tar" which is obtainable from the P.O. Stores Dept.

## 3.—POLE HOLES.

For poles longer than 30 ft. the holes are dug as shown in Fig. 4.

In order to give the pole a firm hold in the ground it is essential that the solid earth round it should be disturbed as little as possible, particularly at right angles to the direction of the line, where the effect of wind pressure on the line has to be resisted. The length of the hole is therefore dug along the length of the line. The width of the hole should be as narrow as possible, being just sufficient to take the butt of the pole and allow for punning between the pole and the sides of the hole. "Stepping" is resorted to in order to obviate the removal of more earth than is absolutely necessary, and at the same time to allow the hole to be worked to the requisite depth. The depth of the hole varies with the height of the pole, but

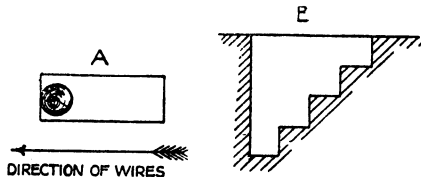

Fig. 4.

it may be taken roughly that poles from 18 feet to 50 feet in length are set at depths from 3 ft. 6 in. to 6 ft. proportionately to the length of the pole in ordinary soil. In soft soils or in sloping banks where there is danger of the pole breaking through the soil, increased depths are used, whilst the depths are reduced in rocky ground.

Where poles of a length not exceeding 30 ft. have to be erected a circular hole slightly tapering towards the bottom and in diameter about 2 inches greater than the butt of the pole is preferable in most kinds of soil. After the soil has been removed by means of a spade for a depth of about 1-1½ ft. special tools known as "Digging Bars and Spoons" are used to complete the excavation. The method of using these tools is to loosen the earth with the bar working towards the centre of the hole and using little more than the force obtained by the tool falling under its own weight; the loosened soil is then easily removed by means of the spoon worked with a circular movement, the tools being used alternately until the required depth of 3 ft. 6 in. to 4 ft. 6 in. is reached. The digging bar is of further use when erecting the pole as it can be placed in the hole to act as a glider, the pointed end being placed downwards. If the nature of the soil allows, cylindrical holes can be quickly excavated by means of an Earth Auger, assisted by the Digging Bar for punning.

## 4.—ERECTION OF POLES.

The butt of the poles is laid over the hole with the length of the pole in the direction of the line. A suitable board is placed vertically against the deep end of the hole to facilitate the entry of the butt when the pole is raised, and also to prevent earth being knocked into the bottom of the hole during the process. The head of the pole is then lifted until ladders can be put underneath it to support the weight. Pole lifters are also used to assist in supporting the pole. The pole is raised to a vertical position by gradually working the ladders and lifters towards the butt, which at the same time is assisted to slide into the bottom of the hole.

When long heavy poles are to be erected, a derrick pole slightly over half the length of the main pole, is erected near the pole hole, and well stayed. The main pole is laid with its point of balance close to the derrick pole to which it is attached by pulley blocks and tackle, the sling chains being fixed so that the pole when raised from the ground will be slightly "butt heavy." The pole is then gradually raised into a vertical position, the butt guided into the hole and the tackle is run out so as to place the pole in the desired position. Guy ropes are used with both methods of erection to prevent accidents whilst the pole is being raised, and to hold it securely in the vertical position whilst the hole is being filled in and punned.

**Filling In.**—Careful filling in of pole holes is of the greatest importance. A layer of stones or stiff earth is punned very

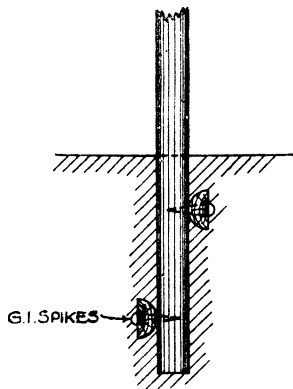

Fig. 5.

tightly round the butt of the pole. The soil is then gradually replaced in the hole, being punned carefully as it is added. One shovel is more than sufficient to keep two punners at work.

12

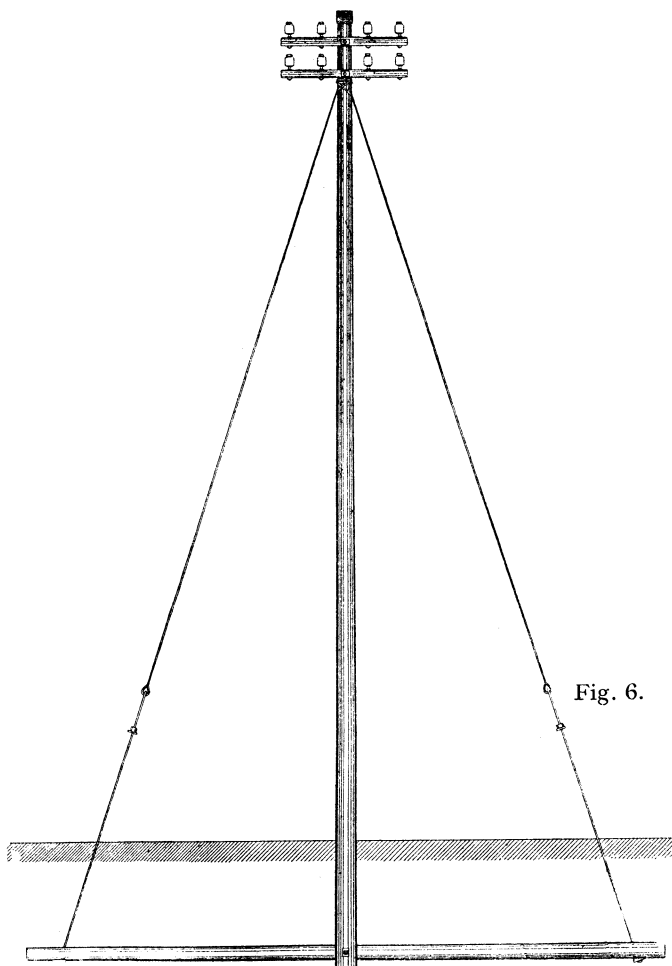

Fig. 6.

It is of special importance that there should be a good bearing surface near the top and bottom of the hole as these are the points about which the pole tends to move under the action of the stresses which it has to withstand.

Where a pole is likely to be required to withstand heavy lateral stresses, such as at sharp angles, or where, owing to the loose nature of the soil, not much holding power is obtained, extra bearing surface is provided below the ground by fixing two stay blocks to the pole as shown in Fig. 5.

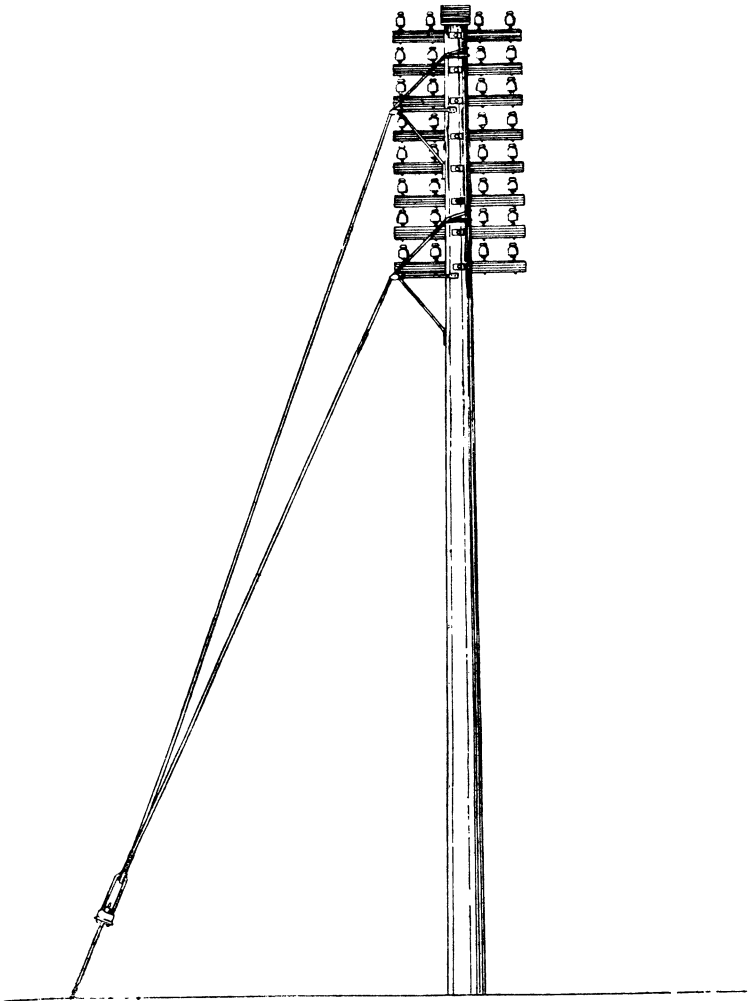

Fig. 7.

*Note.*—For new type of stay crutch, *see* page 17.

When it is necessary to erect a pole in swampy ground, a still more elaborate method of blocking in which a short pole is used is resorted to, as shown in Fig. 6.



## 5.—STAYS.

Lines are stayed to counteract unbalanced stresses due to the wires at terminal and distribution poles, and at angles. Stays are also used to strengthen the line against wind pressure, and to limit the effect of breakdowns. These two types of stays are known respectively as rocking or lateral stays, and line or longitudinal stays.

The attachment of a stay to a pole is always arranged at the point of action of the resultant force for the total load which the pole is intended to carry ultimately. Thus for a line whose ultimate load is to be eight arms, the stay is attached just above the fourth arm.

Where specially heavy stresses are to be counteracted by stays, double-stays of two types known as "V" and "parallel" stays are used. These are indicated in Figs. 7 and 8. The points of attachment of these stays to the pole are arranged at equal distances above and below the point of action of the resultant force upon the pole.

At the ground end stays are made off to a stay-rod attached to a wooden block buried deeply in the ground. The hole in which this block is buried is undercut as shown in Fig. 9, to ensure that the pull exerted by the stay is against solid, undisturbed ground. The stay-rod includes a tightener by means of which the tension of the stay wire can be adjusted.

The distance from the pole of the point at which the rod enters the ground should, wherever possible, be equal to the height of the point of attachment of the stay to the pole from the ground line in the case of terminal and longitudinal stays.

Strand galvanized iron wire, No. 8 gauge, is used for stays. Two sizes are stocked, viz., seven and four strand.

To make off a stay wire to a stay tightener the stay wire is bent round a thimble so that the end projects about 20 inches beyond the thimble. It is drawn closely into the groove of the thimble and the free end then unstranded and the individual wire straightened out. One wire is then taken out and the remainder grouped symmetrically round the stay wire. The wire taken out is then twisted tightly round the stay and the remaining wires by a special stay tool. The process is repeated with the remainder of the unstranded wires.

To make off a stay to a pole, the loose end is taken twice round the pole so that one turn crosses over the other to help to hold it in position. It is fixed by staples and then made off as described above.

When two stays are attached to a pole at the same point one turn will suffice but one stay is made off on the top of the other to help to hold it in position.

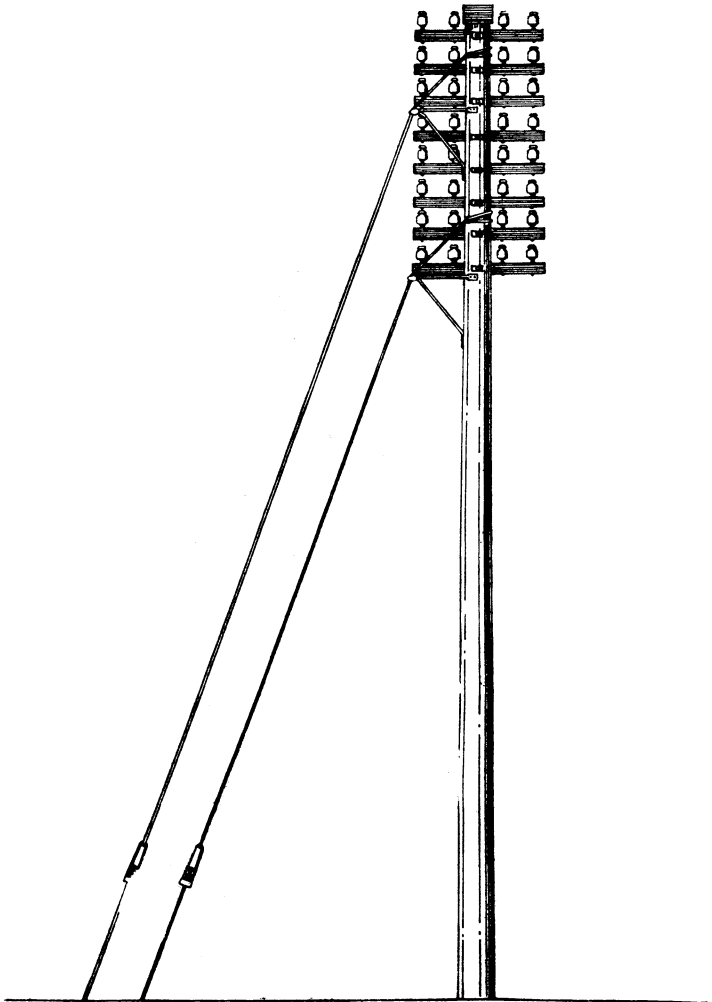

Fig. 8.

*Note.*—For new type of stay crutch, see page 17.

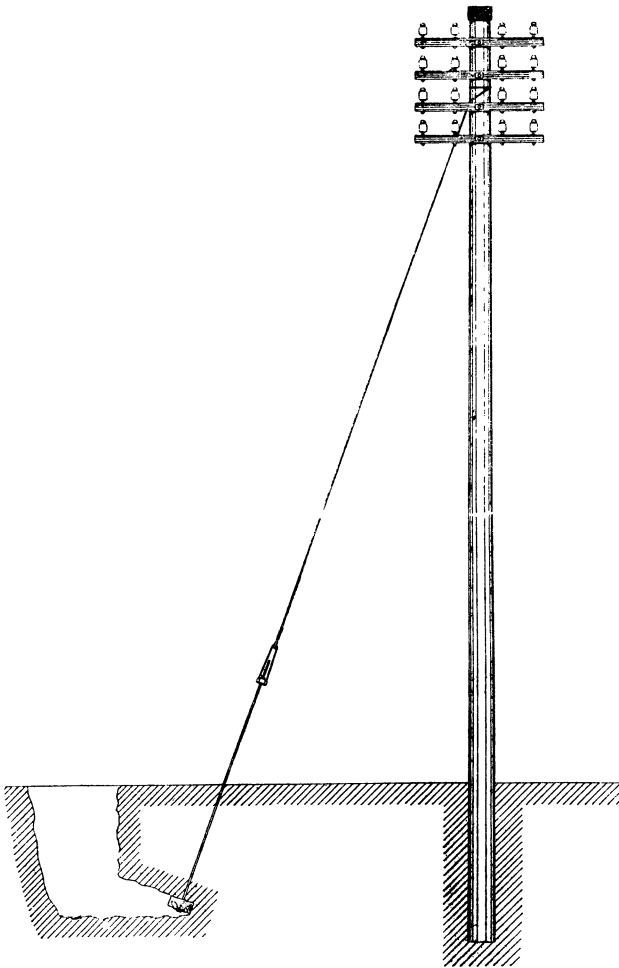

Fig. 9.

Guards consisting of half-round portions of old poles are fitted to stays where there is a possibility of their being damaged or causing damage. These guards render the stays more obvious, and reduced the risk of accident thereby. Care is taken not to fit stays in positions likely to cause accidents to horsemen or foot passengers.

When the choice of position of the stay rod is limited by surrounding objects, it is sometimes impossible to fit the stay so as to give sufficient clearance from the line wires.

Stay crutches are provided for use in those cases, their method of attachment being indicated in Fig. 10.

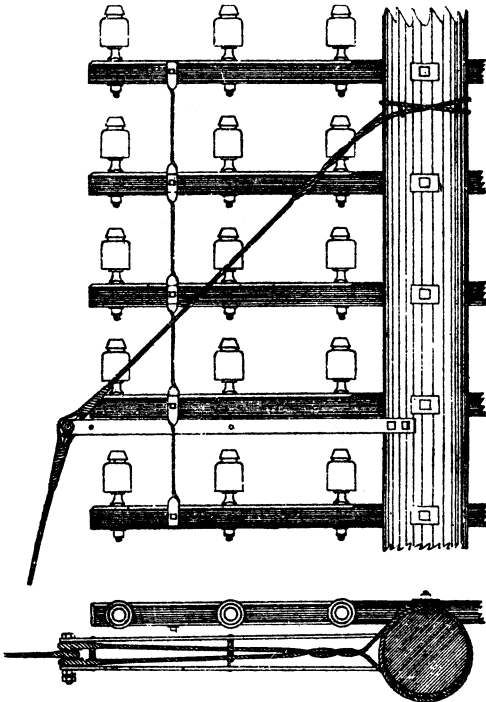

Fig. 10.

Two sizes of stay crutch are provided, No. 2 for 4-way arms and 6-way arms on "H" poles, No. 3 for 8-way arms and 6-way arms on single and on "A" poles.

The crutch is provided with a removable bolt which carries three thimbles. The upper stay is made off on the two outer thimbles and the ground stay on the inner thimble.

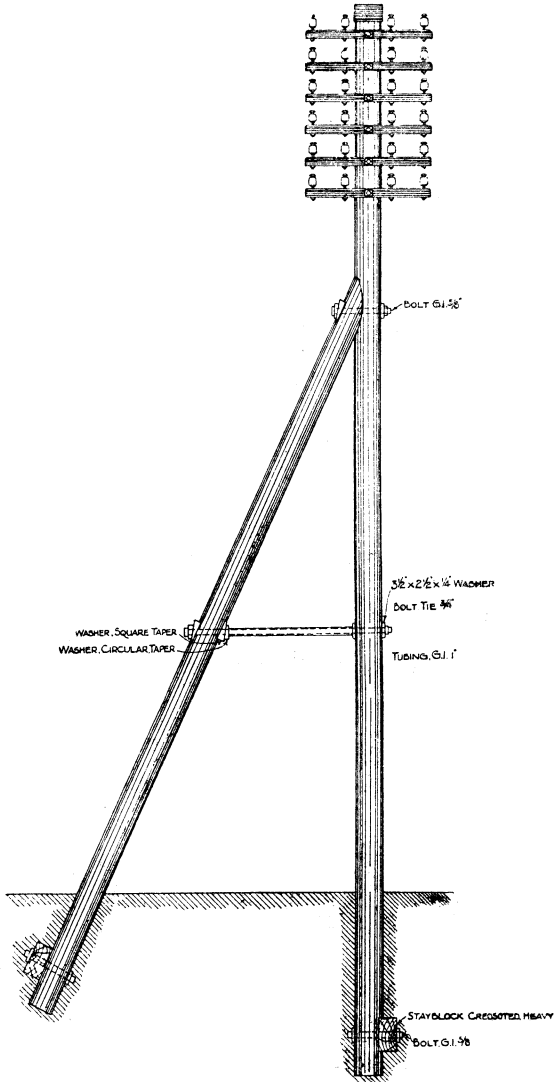

Fig. 11.

## 6.—STRUTS.

Cases often arise where it is impossible to fix a stay against an angle. To meet these cases a strut is used as shown in Fig. 11. A strut fitted in this manner will also act as a stay and resist wind pressure from both sides of the line. The point of attachment of a strut is necessarily just below the lowest arm the line is designed to carry, consequently a stiff pole is used to avoid buckling above the strut.

The strut is scarfed to fit neatly against the pole at the point of attachment and fixed by a  $\frac{5}{8}$  in. bolt. **The pole is never cut at this point.** A stay block is fitted to both pole and strut below the ground line to give a firmer hold. A tie-bolt, stiffened with galvanized iron tubing, is fitted between the pole and the strut about half-way between the point of attachment of the strut and the ground line to render the whole structure more rigid.

## 7.—ARMS.

Wood arms of oak or other hard wood are generally used, but tubular iron arms have been used with iron poles, and in some cases with wooden poles.

The sizes in general use, the circumstances in which they are used, and the borings for insulator spindles are shown in Appendix A.

Arms which are to carry telegraph wires are earthed to prevent interference, due to leakage, with other circuits on the line. An earth wire of the same material as the pole earth wire is used. It passes once round the arm between each pair of insulators, runs along the face of the arm, and is connected to the pole earth wire as shown in Fig. 3.

Arms which are to carry telephone circuits only are not earth wired.

**Fitting of Arms.**—Arms are fitted by slotting the poles and securing in position by an arm bolt. The slots are cut to a depth of  $1\frac{1}{2}$  inches, 12 inches apart. Arm gauges are supplied to facilitate the correct spacing and cutting of the slots. It is important that the slots should be cut of such width that the arm is a tight-driving fit, otherwise when it has been in position for some time it will become loose and unsightly. The slots and bolt holes should be coated with 'tar and creosote' before the arms are fitted.

Arms are all fitted square with each other and at right angles to the pole.

Arms more than 48 in. in length fitted to single poles are braced together by means of arm-combiners fitted between the two outer wires on each side.

**Extension Brackets.**—These are used to avoid extensive shifting when existing 4-way arms are insufficient and wires up to 150 lb. copper are being run. One bracket consists of two

flat steel plates held to the top and bottom respectively of the arm requiring extension by the two insulator spindles of that arm. Holes are provided in the brackets to take two insulator spindles and tubular distance pieces are inserted between the plates on these two spindle positions.

### 8.—INSULATORS.

In general, insulators are made of white glazed porcelain, except for places where it is desired to render the line inconspicuous, when brown earthenware is used, or where heavy damage from stone throwing is experienced, when black insulators of an unbreakable material of various compositions are used. Brown insulators are sometimes used to reduce stone throwing, as the fact that they are not so conspicuous as white insulators renders them less attractive as targets.

In wet weather leakage between the wire and the insulator bolt takes place across the wet surface of an insulator. To ensure a considerable length of dry surface, all insulators except those used for terminating and leading in are made with a double shed.

Appendix B contains a description of the various types of insulators in use.

**Insulator Spindles.**—Appendix C gives the description and use of various types of insulator spindles.

A special spanner, known as spanner for insulator spindles, is provided to prevent the spindle from turning whilst the nut is being screwed on. This spanner is made from a sheet of wrought iron bent over to fit on the upper side of the arm, with slots cut in it to fit the "flats" of the ordinary and terminal insulator spindles.

**Insulator Rings.**—An indiarubber or felt washer is placed on the flange at the bottom of the insulator screw of each spindle before the insulator is screwed on. This acts as a spring washer and decreases the tendency of the insulator to unscrew itself from the spindle owing to vibration. It also enables the insulator to be screwed down tight on its seating without risk of damaging the porcelain.

### 9.—SUBSCRIBERS' OVERHEAD DISTRIBUTION.

Subscribers' premises are fed by overhead wires either (1) by distribution of spur pairs from a continuous line of varying length or (2) by distribution to small areas from single distribution poles located at suitable intervals along an underground line. To reduce the cost of construction and render the system easy to maintain, several small distribution poles are used in preference to one large one, and overhouse attachments are avoided as much as possible.

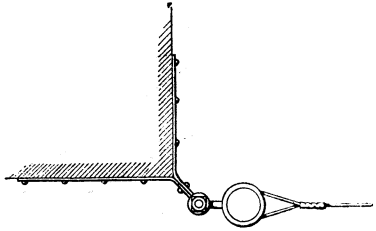
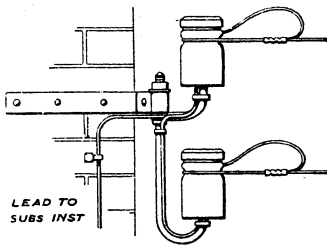

**BRACKET N<sup>o</sup> 5 WITH SPINDLE N<sup>o</sup> 7**

LEAD IN FROM CORNER OF WALL

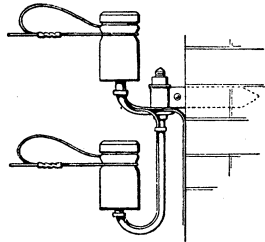
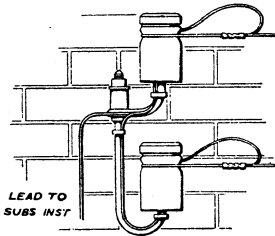

**SPIKE INSULATOR N<sup>o</sup> 1 WITH SPINDLE N<sup>o</sup> 7**

ON FACE OF WALL (WIRES OBLIQUE TO WALL)

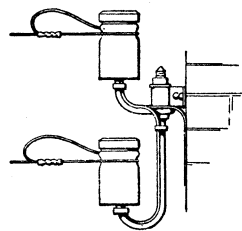
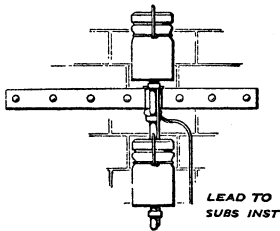
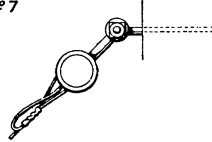

**BRACKET N<sup>o</sup> 5 WITH SPINDLE N<sup>o</sup> 7**

ON FACE OF WALL (WIRES NORMAL TO WALL)

**Fig. 12.**



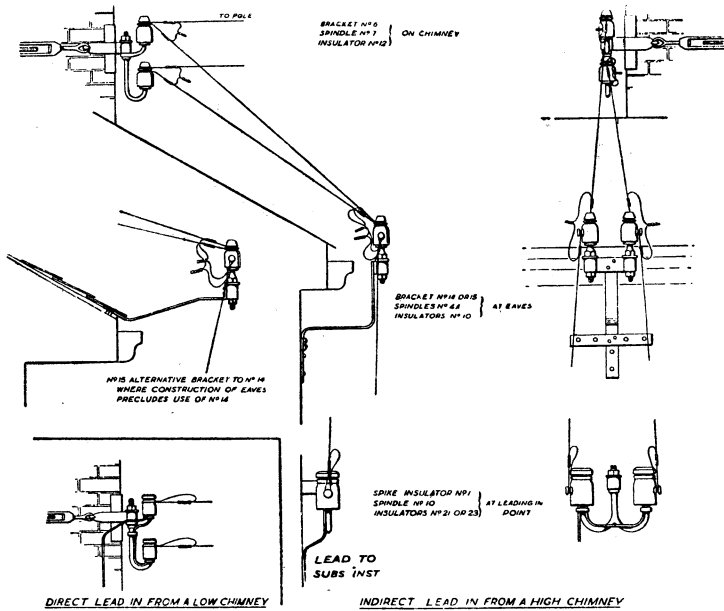

Fig. 13.

Distribution pairs, in the majority of cases, should consist of a single span only, and it is preferable that the wires should be run in a vertical plane instead of in a horizontal plane, as is the practice on a continuous pole line. Where the wires are terminated on a building, the insulators which carry them should invariably be arranged one above the other. The various fittings which support the insulators are illustrated in Figs. 12 and 13.

In arranging the termination of wires on buildings, the point of junction between the open wires and the leading-in cable should be placed so as to be accessible readily by a short ladder, and the cable lead made as short as possible. Attachments to chimneys should be made only when it is impossible to obtain clearance for the wires in any other way. In no case should an attachment be made to a chimney where the height exceeds six times the thickness at the base. Bracket No. 6, which is used when attachment to a chimney is unavoidable, is fixed in position by a band of wire, G.I., 7/14, fitted with a swivel, so as to reduce risk of damage to the structure.

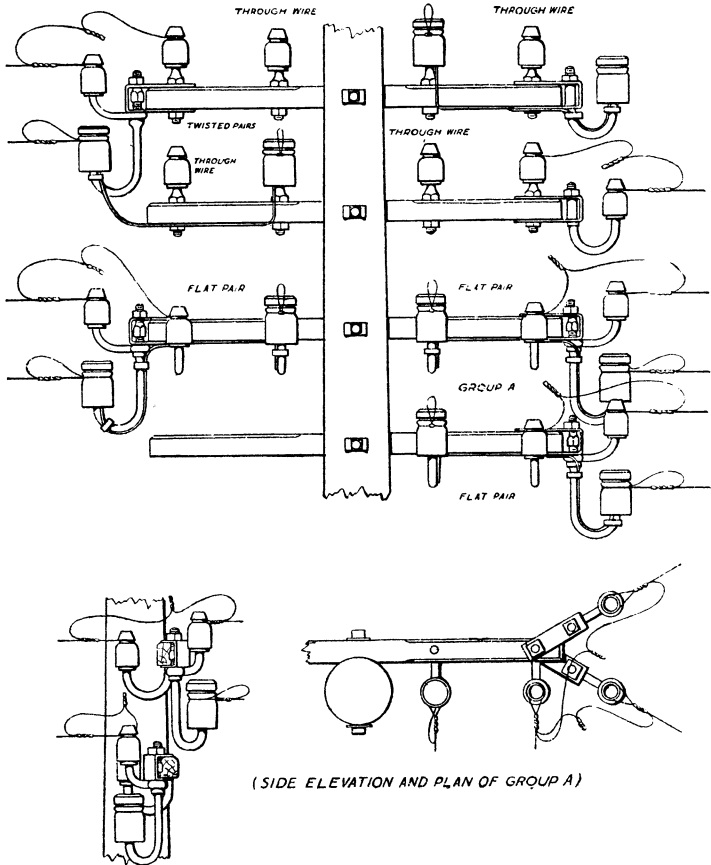
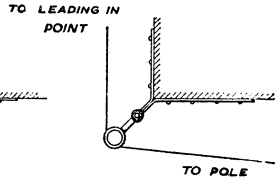
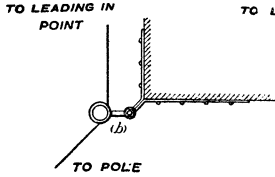
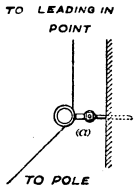

Fig. 14.

When the direction required for the subscriber's pair is such that the wires can be taken direct from insulators spaced in normal positions on the poles, it is not economical to make special arrangements to lead off the wires as a vertical pair. The wires leave the pole in a horizontal plane and gradually twist into the vertical plane as they approach the building. Where the wires cannot be led off direct in this way, spindles should be fixed to the ends of the arms by terminal irons as shown in Fig. 14.



USE OF SPINDLE N°7 WITH (a) SPIKE INSULATOR N°1 OR (b) BRACKET N°5  
TO LEAD ALONG THE FACE OF A BUILDING

USE OF SPINDLE N°7 WITH  
BRACKET N°5  
TO LEAD ROUND THE CORNER OF A  
BUILDING

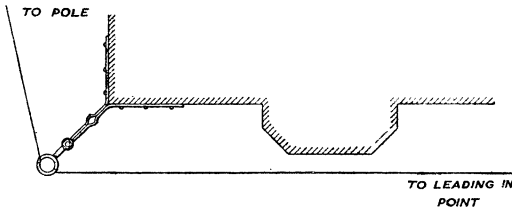

USE OF SPINDLE N°7 WITH BRACKET N°2  
TO LEAD ROUND THE CORNER OF A BUILDING WHEN THERE ARE PROJECTIONS

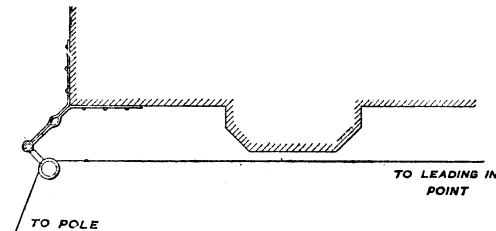

USE OF SPINDLE N°7 WITH BRACKET N°2  
TO LEAD ALONG THE FACE OF A BUILDING WHEN THERE ARE PROJECTIONS

Fig. 15.

When more than one span is necessary between the pole and the leading-in point, the wires should be supported on brackets as shown in Fig. 15, and kept in a vertical plane as far as possible. Attachments should not be made to chimneys if they can be avoided.

## 10.—SPECIAL LIGHT CONSTRUCTION FOR SUBSCRIBERS' AND JUNCTION LINES.

In rural areas, lines are often required to serve outlying subscribers and to carry junctions from small exchanges where there is no possibility of more than a few pairs being required. Standard construction is modified to provide a less expensive line when 4 four-way arms may be regarded as the maximum ultimate requirement. Light poles, as short as possible, with an average span of 65 yards, should be used. Poles from 16 to 20 feet in the normal run of the line, and 24 to 28 feet for road crossings, depending on the number of arms to be carried, are generally suitable. No roofs are fitted, the tops of the poles being merely dressed as for a roof and painted with creosote and tar mixture. No earth wires are fitted unless the poles are in a very exposed situation. One pole step only is fitted.

The Bar and Spoon and Earth Auger methods of pole hole excavation are very suitable for the construction of this type of line and descriptions of these will be found in Section 3.

Creosoted pine arms 36 in. by 3 in. by 2½ in. (*see* Appendix A) are fitted, the pole being slotted to a depth of ¾ in. only. The first arm is fitted 6 in. from the top of the pole, and additional arms at intervals of 12 in.

Small insulators and spindles are used whatever the length of the line or the gauge of the wire.

40 lb. bronze is normally used for line wire, 100 lb. copper being employed where this does not provide the requisite transmission efficiency.

Short, light stay rods without tighteners, known as "Rods, Stay, No. 4," are provided for use with angle and transverse (*i.e.*, side) stays in conjunction with one 400 lb. G.I. wire or two twisted together. Angle and transverse stays should be fitted 3 feet from the top of the pole, no matter how many arms the pole carries, to avoid contact with the line wires.





## APPENDIX C.—SPINDLES.

Description.	Use.
Straight $\frac{1}{8}$ in. large .. .. .	Trunk and junction lines.
" small (for wood arms) .. .. .	Subscribers' lines.
" (for iron arms and brackets) .. .. .	" " on roof ridges.
" with wood screw .. .. .	Where fuse insulators are required.
" $\frac{1}{4}$ in. fuse .. .. .	Trunk lines. Where necessary to terminate on a straight spindle.
" terminal .. .. .	Trunk lines. For terminating.
Single J $\frac{1}{4}$ in. .. .. .	Subscribers' lines and light Trunks For terminating.
" $\frac{1}{8}$ in. .. .. .	(a) In conjunction with spikes, insulator, for terminating.
Double J " 180° .. .. .	(b) Leading off spurs from main lines.
" " vertical .. .. .	(c) Leading in and out.
U Cupholder $\frac{1}{4}$ in. .. .. .	For leading off subscribers' pairs from distribution poles and terminating same on brackets attached to buildings.
U " $\frac{1}{8}$ in. .. .. .	Inserting crosses in straight run Trunks, gauges <i>above</i> 300 lbs. per mile.
Quadruple Cupholder .. .. .	Inserting crosses in straight run Trunks, gauges <i>up to</i> 300 lbs. per mile, and for carrying saddle pairs.
	Inserting crosses in saddle pairs.

Printed under the authority of HIS MAJESTY'S STATIONERY OFFICE  
By HARRISON AND SONS, LTD., 44-47, St. Martin's Lane, London, W.C.2  
Printers in Ordinary to His Majesty.

# LIST OF Technical Pamphlets for Workmen

(Continued.)

---

---

## GROUP E.

1. Automatic Telephony. Step by Step Systems.
2. Automatic Telephony. Coder Call Indicator (C.C.I.) Working.
3. Automatic Telephony. Keysending " B " positions.

## GROUP F.—

1. Subscribers' Apparatus C.B.
2. Subscribers' Apparatus C.B.S., Part I—C.B.S. No. 1 System.
3. Subscribers' Apparatus Magneto.
4. Private Branch Exchange—C.B.
5. Private Branch Exchange—C.B. Multiple, No. 9.
6. Private Branch Exchange—Magneto.
7. House Telephones.
8. Wiring of Subscribers' Premises.

## GROUP G.

1. Maintenance of Secondary Cells.
2. Power Plant for Telegraph and Telephone Purposes.
3. Maintenance of Power Plant for Telegraph and Telephone Purposes.
4. Telegraph Battery Power Distribution Boards.

## GROUP H

1. Open Line Construction, Part I.
2. Open Line Construction, Part II.
3. Open Line Maintenance.
4. Underground Construction, Part I—Conduits.
5. Underground Construction, Part II—Cables.
6. Underground Maintenance.
7. Cable Balancing.
8. Power Circuit Guarding.
9. Electrolytic Action on Cable Sheaths, etc.
10. Constants of Conductors used for Telegraph and Telephone Purposes.

## GROUP I.

1. Submarine Cables.

## GROUP K.

1. Electric Lighting.
2. Lifts.
3. Heating Systems.
4. Pneumatic Tube Systems.
5. Gas and Petrol Engines.