



WS No. 19 Mark III

**This file has been down loaded from
The Wireless-Set-No19 WEB site.**

**All files from this WEB site are free of charge.
If you have been charged for this file then please
contact the person you obtained it from as he/she
has illegally obtained both the file and money they have
charged you.....**

Crown Copyright Reserved

P.W.—G.2.

Post Office Engineering Department

TECHNICAL PAMPHLETS FOR WORKMEN

Subject :

Power Plant for Telegraph and Telephone Purposes.

*ENGINEER-IN-CHIEF'S OFFICE,
1919.*

(Reprinted January, 1927, including Correction Slips to date.)

(" February, 1931, " " " ")

(" March, 1932, " " " ")

LONDON:

PRINTED AND PUBLISHED BY HIS MAJESTY'S STATIONERY OFFICE.

To be purchased directly from H.M. STATIONERY OFFICE at the following addresses:
Adastral House, Kingsway, London, W.C.2; 120, George Street, Edinburgh;
York Street, Manchester; 1, St. Andrew's Crescent, Cardiff;
15, Donegall Square West, Belfast;
or through any Bookseller.

1932.

Price 6d. Net.

LIST OF Technical Pamphlets for Workmen

GROUP A.

1. Magnetism and Electricity.
2. Primary Batteries.
3. Technical Terms.
4. Test Boards.
5. Protective Fittings.
6. Measuring and Testing Instruments.
7. Sensitivity of Apparatus.
8. Terms and Definitions used in Telegraphy and Telephony.

GROUP B.

1. Elementary Principles of Telegraphy and Systems up to Morse Duplex.
2. Telegraph Concentrators.
3. Wheatstone. Morse Keyboard Perforators.
4. Quadruplex. Telegraph Repeaters, Sx., Dx., and Quad.
5. Hughes Type-printing Telegraph.
6. Baudot Multiplex.
7. Western Electric Multiplex. Murray Multiplex. Other Systems.
8. Fire Alarm Systems.

GROUP C.

1. Wireless Transmission and Reception.
2. Interference with Reception of Broadcasting.

GROUP D.

1. Elementary Principles of Telephony.
2. Telephone Transmission. "Loading." Telephone Repeaters and Thermionic Valves.
3. Principles of Telephone Exchange Signalling.
4. Magneto Exchanges—Non-Multiple Type.
5. Magneto Exchanges—Multiple Type.
6. C.B.S. No. 1 Exchanges—Non-Multiple Type
7. C.B.S. Exchanges—Multiple Type.
8. C.B. Exchanges—No. 9 Type.
9. C.B. Exchanges—No. 10 Type.
10. C.B. Exchanges—No. 12 Type.
11. C.B. Exchanges—22 Volts.
12. C.B. Exchanges—40 Volts.
13. Trunk Telephone Exchanges.
14. Telephone Exchange Maintenance.
15. Telephone Testing Equipment.
16. Routine Testing for Manual Telephone Exchanges.
17. Internal Cabling and Wiring.
18. Distribution Cases, M.D.F. and I.D.F.
19. Cord Repairs.
20. Superposed Circuits, Transformers, etc.
21. Call Offices.

[Continued on page iii. of Cover.]

Power Plant for Telegraph and Telephone Purposes.

(G.2.)



*The following pamphlets in this series are of
kindred interest :—*

- G.1. Secondary Cells.
- G.3. Maintenance of Power Plant for Telegraph and
Telephone Purposes.
- G.4. Telegraph Battery Power Distribution Boards.

POWER PLANT FOR TELEGRAPH AND TELEPHONE PURPOSES.

TABLE OF CONTENTS.

	PAGE
THEORY OF MOTORS AND GENERATORS	3
ALTERNATING CURRENTS	5
UNIDIRECTIONAL CURRENTS... ..	6
DIRECT CURRENT GENERATORS	6
COMMUTATION	9
SHUNT WOUND MACHINES	11
DIRECT CURRENT MOTORS	12
ALTERNATING CURRENT MOTORS	14
CONTROL GEAR. D.C. MOTORS	17
CONTROL GEAR. A.C. MOTORS	20
GENERATOR SWITCH GEAR	21
CIRCUIT BREAKERS	21
RINGERS	24

POWER PLANT FOR TELEGRAPH AND TELEPHONE PURPOSES.

THEORY OF MOTORS AND GENERATORS.

When a conductor is moved across a magnetic field an electromotive force is produced in it in such a direction that the current flowing in this conductor, if it forms part of a closed circuit, tends to oppose the motion of the conductor.

The direction of this current can be ascertained by the

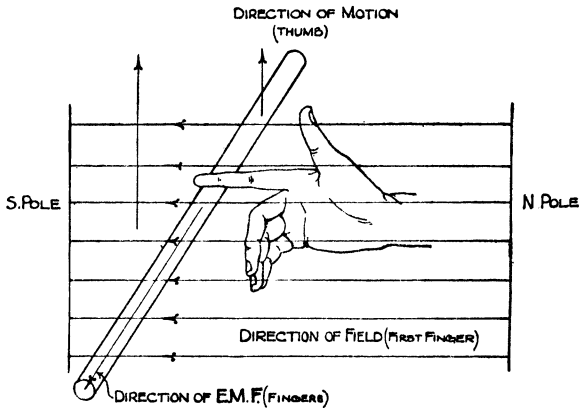

Fig. 1.

following rule. Bend the right hand so that the thumb, the first finger and the remaining fingers point in three directions at right angles to one another. Turn the hand so that the thumb points in the direction of the motion, and the forefinger points along the direction of the lines of force, then the remaining fingers point in the direction of the E.M.F. induced in the conductor (Fig. 1).

(10214) Wt. 26664/87/2237 2000 3/32 Hw. G.344 (T.S. Ps. 404 G.2.)

The simplest form of generator is the Magneto Generator (Fig. 2). The magnetic field is produced by a permanent horse-shoe magnet, and an H or shuttle armature of iron revolves in the space between the poles. In the slots a coil of insulated wire is wound and its two ends are connected to two rings called slip rings mounted on the armature shaft.

If the direction of rotation of the armature be counter clockwise, as shown by the arrow, and the circuit be completed by

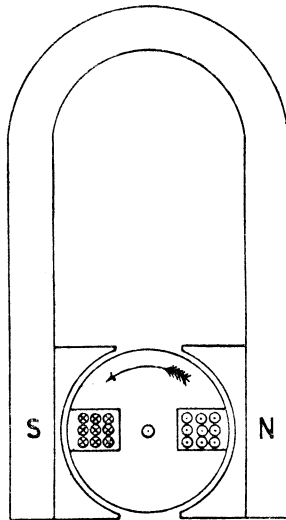

Fig. 2.

connecting the slip rings together, it will be seen by applying the rule given above that the generated current flows towards the spectator as shown by \odot in the wires which are passing the N. pole, and the current in wires to the left will be in the opposite direction as shown by \otimes . At this position the E.M.F. generated has its highest value because the conductors cut through the maximum number of lines of force per second. After the armature has made a quarter revolution the conductors are not under the influence of either the north or the

south pole (*see* second quarter, Fig. 3), consequently no E.M.F. is being generated. From the position marked first quarter to the position marked second quarter, the generated E.M.F. would be gradually falling off in magnitude as the number of lines of force cut through per second by the conductors is decreasing. Let a curve be drawn as in Fig. 3 (upper part). In position A the conductors are moving parallel to the direction of the lines of force and are not cutting through them, hence no E.M.F. is being generated. As the armature turns through the first quarter revolution the E.M.F. rises gradually, attaining its maximum value (represented by the height B F) when the conductors are cutting through lines of force at the maximum rate, *i.e.*, when they pass under the centres of the poles. As the conductors turn through the second quarter, the E.M.F. generated gradually falls, attaining zero value at position C. During

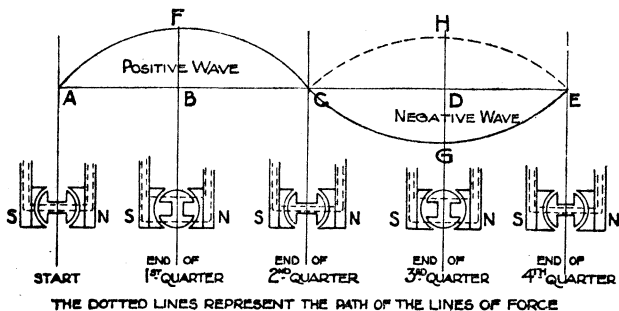

Fig. 3.

the third quarter revolution the E.M.F. generated rises in the reverse direction, reaching a maximum negative value, represented by the height D G at G, for the conductors which were, at first, under the north pole are now under the influence of the south pole and *vice versa*. During the last quarter revolution the E.M.F. falls gradually from a negative maximum and reaches its zero value at E, when the armature is in the same position as the starting position. Thus in one revolution, the E.M.F. generated has passed through a complete series of values and is said to have completed one period.

ALTERNATING CURRENTS.

The E.M.F. generated by such a generator is called an alternating E.M.F., as it alters its direction at each half revolution of the armature. If the ends of the coil are connected to a closed circuit, this alternating E.M.F. produces an Alternating Current.

UNIDIRECTIONAL CURRENTS.

If the two ends of the armature coil are connected to the two halves of a split ring or commutator on which two brushes bear (Fig. 4), the two halves being insulated from each other, this alternating current can be converted into a unidirectional current. The outer circuit is connected to two brushes pressing upon the commutator, and the position of the latter (Fig. 4) corresponds with the position of the armature coil in Fig. 2. Fig. 7 indicates the relative position of armature coils, commutator segments and brushes. At the instant represented by Fig. 4 a current is flowing from the right-hand side of coil to bottom brush, outer circuit, top brush, and back to the coil. When the position shown in Fig. 5 has been reached, no current is being generated by the coil, and the latter is short-circuited by the brushes being in contact with the two halves of the commutator at once. As the rotation of the commutator proceeds, the half connected to the left-hand side of the coil comes into contact with the bottom brush, and it will be remembered that the E.M.F. has changed its direction in the coil, so that the current still continues to flow out to the bottom brush (Fig. 6). After a further half revolution the connections of the coil are again reversed, so that the current always flows in one direction in the outer circuit, and has the form of A F C H E (Fig. 3) in the external circuit, and A F C G E in the armature coil itself.

DIRECT CURRENT GENERATORS.

This pulsating current is not suitable for charging accumulators, though, providing its reversals occurred sufficiently frequently, it could be used for incandescent lighting. For all purposes a more steady current is desirable, and armatures and commutators have consequently been so improved that a current approximating very nearly to the unvarying current given by secondary cells can be produced.

A diagrammatic sketch of a small armature is shown in Fig. 8. Armatures actually used differ mainly in having a larger number of coils and of commutator segments. This armature is of the drum type, and consists of a number of coils connected up as described later, wound in slots or on the surface of an iron core formed of thin varnished stampings. Stampings are used instead of a solid piece of iron to prevent the formation of eddy currents, and consequent heating and loss of energy which would be produced by the rotation of a solid mass of iron in a magnetic field. These eddy currents would flow from end to end of the armature, but the resistance provided by the varnish between the stampings is sufficient to prevent their formation. Referring to Fig. 8 it will be noticed that the

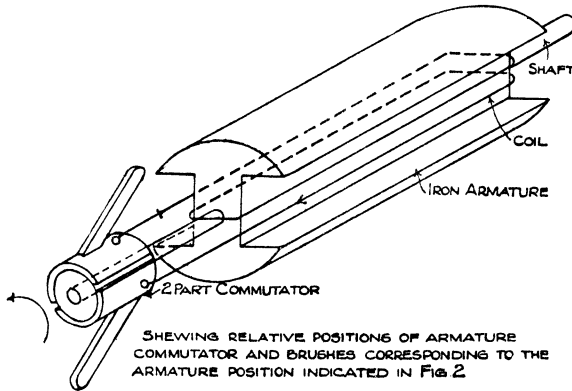
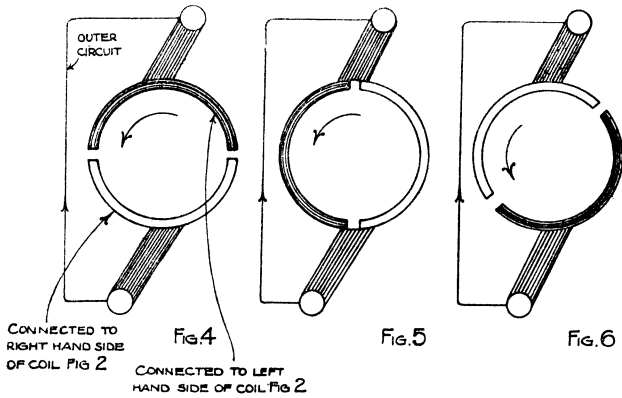
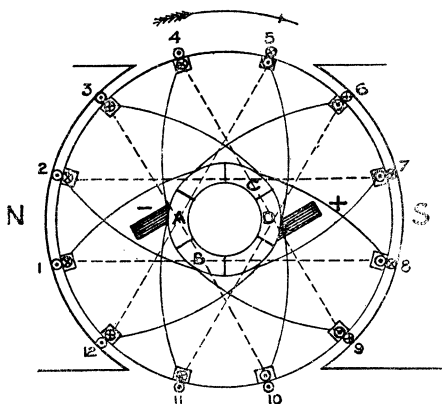

Fig. 7

north pole is now shown on the left, and the direction of rotation is clockwise : the inner layer of conductors only is referred to.

The conductors numbered 12, 1, 2 and 3, will have an E.M.F. induced in them in the direction shown by \otimes , and conductors No. 4, 5, 10 and 11, which lie almost outside the magnetic field, *i.e.*, in the neutral zone, will have little or no E.M.F. induced in them; whilst 6, 7, 8 and 9 have an E.M.F. in the opposite direction to that in 12, 1, 2 and 3.

Thus there are four conductors giving E.M.F.'s in one direction and four giving E.M.F.'s in the opposite direction. The



THE INNER CONDUCTORS INDICATE THE DIRECTIONS OF E.M.F. AND OF CURRENT IN A GENERATOR, AND ALSO OF BACK E.M.F. IN A MOTOR. THE OUTER CONDUCTORS INDICATE THE DIRECTIONS OF CURRENT IN A MOTOR.

Fig. 8.

coils are connected as shown in Fig. 8 by the dotted and the curved lines, the former representing the connections at the back of the armature and the latter those at the front or commutator end.

With the brushes in the positions shown, there are two connections to the left-hand brush : one to conductor 4 and one to 11. The first goes to conductor 4, which is in the neutral zone, *via* the back connection to 9, where the E.M.F. is towards the spectator, thence to 2, where the E.M.F. is away from the spectator, and thus in series with that in 9, thence to conductor 7 *via* the back connection, thence to 12, and finally to the commutator segment with which the positive brush is in contact. It will be seen that all the induced E.M.F.'s are added together by this method of connection.

By the alternative path the positive brush is reached; *via* conductors 11, 6, 1, 8, 3 and 10, and the E.M.F.'s induced in four of these conductors are in series as in the other half of the armature.

When the armature is rotating and no current is being withdrawn the two halves of the armature are thus in parallel, each generating the same E.M.F. No current will circulate from one half of the winding to the other, as the two E.M.F.'s are equal and oppose each other.

Immediately an outer path is provided the two E.M.F.'s combine and send a current to feed the outer circuit, each half of the armature providing half the current.

COMMUTATION.

As the armature revolves the commutator will rotate, so that for a moment the negative brush touches both segments A and B and the positive C and D at the same time (Fig. 8). Conductors 4 and 9, which have currents flowing in them, merely because they are in series with other conductors in which E.M.F.'s are being generated, will thus be short-circuited. These conductors have no E.M.F.'s induced in them, as they will both at that time be in the neutral zone, but owing to their self-induction the current they are carrying does not stop suddenly, but dies away gradually. If during this dying away of the current the armature moved so much that the bars A and B were no longer short-circuited by the brush, the dying current would be interrupted, and a current in the opposite direction would suddenly flow through the two conductors forming this coil, as they would have become a portion of the other half of the armature, and sparking would be caused. To prevent this the current must be brought down to zero whilst the coils are still short-circuited, and immediately afterwards, but while the coils are still short-circuited, an E.M.F. must be induced in them in the same direction as the current which will flow through the winding in its next position.

This may be effected by moving the brushes from the middle of the neutral zone a little forward in the direction of rotation, in which case the fringe of the magnetic field of the forward pole induces a small E.M.F. in the short-circuited winding. This is just sufficient (1) to reduce the dying current to zero and (2) to induce a current in the short-circuited coil equal to and in the same direction as the current which will flow in the coil when it leaves the brush and becomes a portion of the other side of the armature winding.

Brushes.—The brushes on the generators used for charging low voltage batteries are made of copper gauze, foliated copper, or a combination of copper and graphite, in order to ensure that the resistance of the circuit is kept as low as possible and

to avoid the energy loss and heating which would otherwise arise from the heavy currents and low voltages employed.

The E.M.F. produced by a machine such as that described is given by the formula

$$E = \frac{P \times C \times F \times N}{100,000,000 \times 60} \dots\dots\dots (1)$$

where

E = E.M.F. generated in volts.

P = No. of field poles.

C = Number of armature conductors in series between a positive and negative brush by either path.

F = Total number of lines of force passing from any one pole through the armature.

N = Number of revolutions per minute.

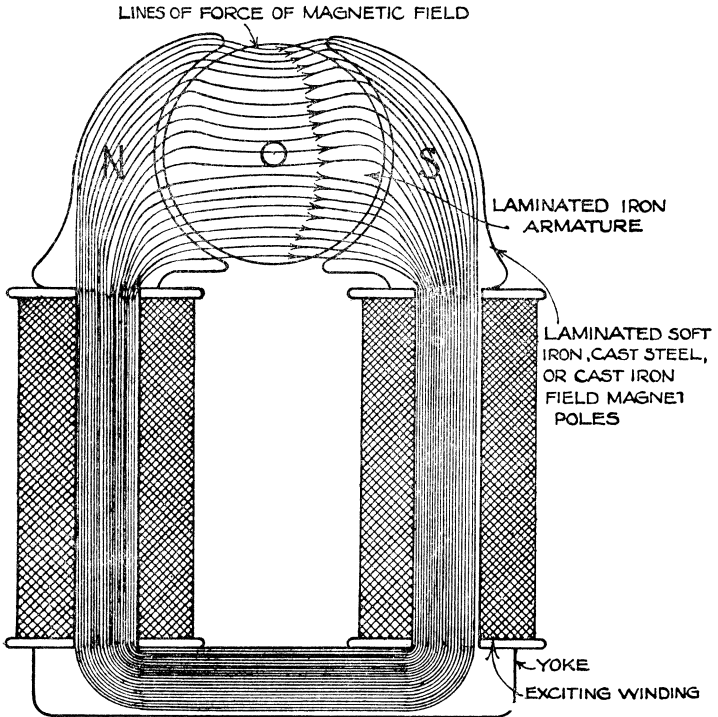

Fig. 9.

SHUNT WOUND MACHINES.

The magnetic field required for machines used for battery charging is produced by winding a coil of relatively fine wire upon soft iron poles, the coils being joined in series with one another and connected across the brushes. Such a machine is said to be shunt wound. The pole pieces are of soft iron laminations or cast steel, and are fitted to the magnet frame or yoke as shown in Fig. 9, which illustrates the magnetic circuit of a two-pole machine.

When such a machine begins to rotate the armature conductors cut the lines of force resulting from the residual magnetism of the iron poles, and generate a small E.M.F. The armature consequently produces a small current in the shunt

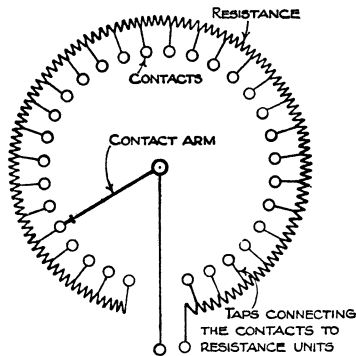

Fig. 10.

field circuit which increases the magnetisation of the iron. This strengthened field then produces a larger E.M.F. in the armature, so that in a short time the field is built up and the E.M.F. attains its full value.

Shunt Regulators.—From the formula given above for the E.M.F. of a machine it will be seen that the voltage of a given armature can be varied by varying N or F .

Departmental machines are generally motor driven, and although the speed of the motor can be varied, the more economical way to obtain the necessary variation for battery charging is to vary F .

F , or the number of lines of force, is dependent upon the number of ampère turns upon the field magnet.

Rheostats, or Field Regulators.—The current in the field winding can be varied by inserting resistance in series with the field coils. Such adjustable resistances or rheostats are

arranged as shown in Fig. 10, one connection being made to the end of the resistance and the other to the contact arm. Rheostats are formed of wire of high specific resistance wound on or embedded in incombustible, insulating supports, and fitted in an iron frame covered with perforated metal. They are usually mounted at the back of the power board, while the contact arm is rotated by a spindle fitted with a handwheel mounted on the front of the board. The contact arm moves over the contacts which are mounted on a slate panel at the back of the theostat, so arranged as to be accessible for cleaning.

DIRECT CURRENT MOTORS.

If the drum armature already referred to be supplied with current from an external source, the current flowing into the armature at the positive brush will divide equally, half passing

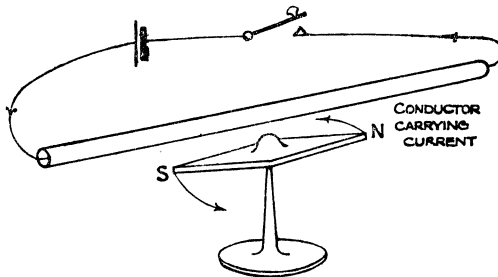

Fig. 11.

through each of the two paths through the armature and the two reuniting at the negative brush where they leave the machine. The direction of these currents, indicated by the outer belt of conductors (Fig. 8), will be seen to be opposite to that of the E.M.F. generated by the direction of rotation.

The direction in which the armature will be moved can be found by Ampère's rule, which is as follows :—

“Imagine a man swimming in the wire *with* the current and turning to face a magnetic needle : then the N. pole will be deflected to the left hand of the swimmer.” (Fig. 11.)

As regards the left-hand conductors it will be seen that the interaction of the current from the external source and the magnet field is such that there is a force tending to turn the N pole in a direction opposite to that of the movement of the hands of a clock. As this pole is fixed the conductors and armature will be urged in the opposite direction because the armature is free to rotate. Consequently the armature will

rotate in a clock-wise direction, that is to say, in the same direction as it would have done when generating an E.M.F. which makes the right-hand brush positive. Similarly the right-hand conductors will urge the armature in the same direction. Commutation, *i.e.*, the reversal of current in each conductor, will be effected in the same manner as in the case of the generator, but the brushes will have to be given *backward* lead, *i.e.*, will have to be rocked round a short distance against the direction of rotation of the armature.

While this armature is rotating as a motor the conductors will be cutting the lines of force, and consequently an E.M.F. will be produced in them in the same direction as when it was acting as a generator, since it does not make any difference whether the rotation is produced by internal or external forces. This E.M.F. opposes the current due to the applied E.M.F.

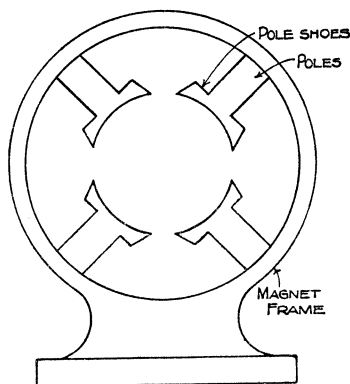
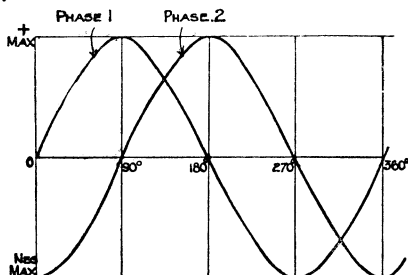

Fig. 12.

and is known as the "back E.M.F." and causes the current in the armature to be far smaller than it would have been if it were calculated by Ohm's Law, under which $C = \frac{E}{R}$, where C = current, E = applied E.M.F., and R = resistance of the armature in ohms. Obviously the back E.M.F. of a motor can never become as great as the E.M.F. of the source of driving current, since if this were the case, no current would flow in the armature and it would cease to rotate. When the motor is not doing any work the back E.M.F. is of such a value that the current taken by the motor exerts a force only sufficient to overcome the friction of the bearings, brushes and resistance due to air and the losses in the iron. If a load is put on the motor pulley the small current is no longer sufficient to drive the motor, and the speed, and consequently the back E.M.F.

decreases. Therefore the incoming current increases until a balance is again obtained. The field coils of motors used by the Department for telegraph and telephone machines are shunt wound and therefore the field strength remains nearly constant regardless of the load, and consequently the speed at full load differs very little from that at no load. They are usually of the 2-pole or 4-pole type, the yoke being arranged so as to form the frames of the machines as in Fig. 12. In smaller machines the bearings are carried in end plates bolted to the frame, whilst in larger types separate pedestals carrying the bearings are provided.



NOTE 360° CORRESPONDS TO ONE COMPLETE REVOLUTION OF AN ARMATURE OF A TWO POLE MACHINE & TO ONE COMPLETE PERIOD.

Fig. 13.

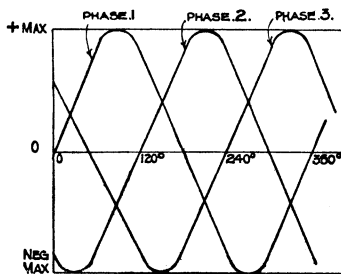

NOTE 360° CORRESPONDS TO ONE COMPLETE PERIOD

Fig. 14.

ALTERNATING CURRENT MOTORS.

There are three systems of alternating currents supplied from public mains—single phase, two phase and three phase.

Single-phase currents are similar to those shown in Fig. 3, and only two wires are needed for distribution. In two-phase supplies, four (or sometimes three) wires are used, each pair giving a single-phase supply, the maximum value of the current

position 0 degree the current in phase 1 is zero, and consequently the current and magnetic field due to coil *aa* supplied by this phase have zero value, *see* Fig. 15. The current in phase 2 at the same instant is at a negative maximum, and assuming that it flows in the coils *bb* in the direction shown in Fig. 15, the magnetic field produced by that coil will have the direction shown by the arrow, that is to say a N and S pole will be produced in the region of the coils *aa*. The current in coil *aa* begins to grow, while that in *bb* begins to decrease, hence *bb* continues to produce a N pole at the bottom whilst coil *aa* begins to produce a N pole at the left in the region of coil *bb*. Both actions are therefore combined. There will consequently be a N pole in the left-hand bottom quadrant which, as the current in *aa* rises and that in *bb* decreases, will travel nearer to the region of *bb*. This rise of current in *aa* and fall of current in *bb* continues until, after a quarter of a cycle or 90 degrees displacement is completed, the current in phase 1 has a positive maximum and in phase 2 has reached zero. Coil *aa* will now produce a field as shown by the arrow in Fig. 16, with a N and S pole in the region of coil *bb*. Similarly at a quarter period later the field will have the direction shown in Fig. 17; at the end of the third quarter period it will have the direction shown in Fig. 18; and at the end of a complete period it will again have the direction shown in Fig. 15.

It will be seen that the effect of supplying a two-phase current to a stator, wound as described, is to produce a rotating magnetic field which revolves once during each complete period of the supply current.

A three-phase supply produces a rotating field in the same manner, the stator coils being wound 120 degrees apart.

Rotors.—If a rotor, composed of an iron core in the slots of which copper conductors are laid and joined together at their ends, is placed in the rotating field, currents will be induced in it which will tend to resist the relative motion of the field and rotor. Hence the latter experiences a “torque,” and begins to run in the same direction as the rotating field set up by the stator. If the rotor is not loaded, very small currents will suffice to provide the force necessary to overcome the friction of its bearings. Now the current induced in the rotor is proportional to the E.M.F., and the latter depends on the relative speeds of the field and rotor (the difference between these speeds expressed as a percentage of the speed of the field is known as the “slip”). Hence on no load the rotor will run at a speed very nearly approaching that of the field. As a load is applied to the rotor the speed decreases until the current generated in the rotor is sufficient to produce the torque required.

Hence, as the load increases the slip increases up to a certain limit. In other words, the speed of the armature diminishes as the load increases.

Single-Phase Motors.—A single-phase supply only produces a pulsating field which reverses its direction each half period, as will be evident by studying coil *aa* alone in Fig. 15. If induction motors supplied from a single-phase system are once started, they will continue to run owing to the inter-action of the fields set up by the stator and rotor.

Starting is accomplished by the use of an additional winding or "auxiliary phase" upon the stator, which is displaced 90 degrees from the main winding as in a two-phase machine. This winding is supplied from the same source, but through a high inductance, which has the effect of making the current through it lag nearly $\frac{1}{2}$ of a period behind the E.M.F. This means that the rise and fall of the current occur $\frac{1}{2}$ of a period later than, and therefore out of phase (or out of step) with, those of the E.M.F., whereas the current in the main winding is approximately in step with the E.M.F. Thus the equivalent of a *two-phase supply* and a *two-phase motor* has been produced, for use, however, during starting only. It will be remembered that a two-phase machine has a rotating field, and this is what is required to make the single-phase motor self-starting.

Stator of Induction Motors.—The stator coils of induction motors are wound in slots cut in the stator core, which is composed of thin iron stampings bolted to the frame of the motor. The bearings are similar to those in the direct current motor. The rotor is also built up of thin iron stampings, and is of the squirrel-cage type, composed of copper bars short-circuited at their ends, for small motors up to about 2 B.H.P. For larger types a "wound" rotor is employed, to enable a resistance to be inserted in the rotor circuit at starting, in order to prevent the current induced in the rotor obtaining too great a value and, owing to the transformer action of the stator and rotor, to prevent the current taken by the stator being too large.

With wound rotors the winding is similar to that of the stator, the ends being connected to slip rings on which brushes bear, to enable the connections to the external resistance to be made. The object of using thin iron laminations in the rotor and stator is to reduce iron losses and to prevent eddy currents being generated by the rapid reversals of magnetism which take place owing to the reversals of current in the stator coils.

The periodicity or number of double reversals per second of the supply is from 25 to 100 cycles per second.

CONTROL GEAR.—DIRECT CURRENT MOTORS.

From the previous consideration of the D.C. Motor it will be apparent that such a motor cannot be directly switched on to the supply mains whilst stationary, as its resistance is extremely small. Means have, therefore, to be provided for starting it with a resistance in series with the armature and

for cutting out this resistance gradually, as the motor gains speed and its back E.M.F. rises. We have, therefore, three things to provide for :—

1. The connection of the supply mains to the motor
2. The prevention of the current from obtaining a dangerous value.
3. The provision of an adjustable resistance for starting the motor.

1. Switches used for connecting motors to the supply mains are of the "quick break type," enclosed in iron cases, operated by a handle outside the case, and so arranged as to make and break the current on both poles simultaneously. The blades of the switch are made as shown in Fig. 19; one blade is provided for each pole, the blades being rigidly coupled together by an insulating piece.

The contact pieces shown in section in Fig. 19 are formed

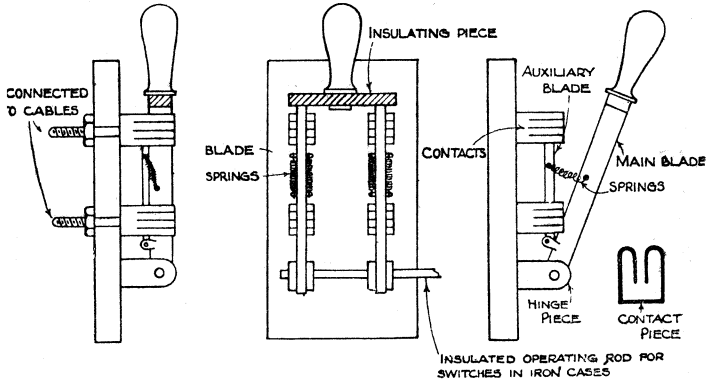

Fig. 19.

of hard springy copper, and are mounted on a slate base. One pair is connected to the mains, and the other pair to the motor or starter. The main blades are provided with auxiliary blades hinged on, and connected to the main blades by springs, so that when the switch is pulled off, the auxiliary blades remain in the contacts after the main blades have been withdrawn. When the tension of the springs is sufficient to overcome the friction of the contacts, the auxiliary blades leave the contacts and are pulled to the main blade quickly by the springs, thus ensuring a quick break and preventing "arcing." These switches are enclosed in iron cases when they are connected to a supply circuit.

2. To guard against the current rising to a dangerous value, "cut-outs" or "fuses" are used. Each consists of a fibre tube in which is placed a wire of thin copper, tin, or tin-lead alloy,

embedded in sand or similar material. This fuse wire is connected to stampings mounted on the end of the tubes, so arranged that the fuse can be bolted to contacts or slipped into clips similar to those shown for the switch. The contacts are mounted on the power board, and connected to the supply on the motor side of the main switch.

If the current becomes excessive the fuse wire melts, and the object of embedding it in sand is to prevent molten metal flying out, as well as to prevent any tendency of the current to arc or flash across the contacts.

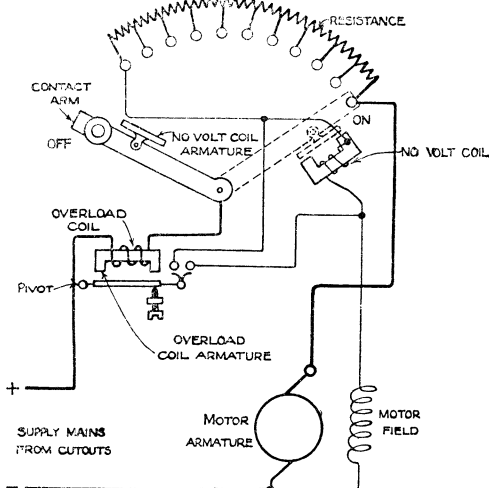

Fig. 20.

3. In addition to providing a means of placing a variable resistance in the motor circuit for starting purposes, the "starting switch" is usually fitted with a "no volt" release, which allows the starter arm to return to the off position when the supply fails, and an adjustable overload release is sometimes provided, which releases the arm of the starter and so stops the motor in the event of the current exceeding a predetermined safe value.

Direct Current Starting Switch.—A starting switch for a shunt-wound D.C. motor is shown diagrammatically in Fig. 20.

The contact arm, when turned towards the "On" position, makes contact with the first stop, which is connected through the "no volt" coil to the field circuit of the machine. The latter is thus completed, from the positive main through overload coil, contact arm, first stop, "no volt" coil, motor field to negative main. The field magnets and the "no volt" coil are

therefore energised. The contact arm also completes the circuit of the armature from the positive main, overload coil, contact arm, first stop, resistance, armature to negative main and then the motor starts. As the contact arm is moved round it cuts the resistance out of the armature circuit step by step until the whole of the resistance has been cut out. The iron armature carried on the contact arm is now in contact with the pole faces of the "no volt" coil, which holds the contact arm in the "full on" position against the tension of a spring fixed around the pivot of the contact arm. The field current now passes from the positive main through the overload coil, contact arm, iron pole pieces of "no volt" coil, winding of "no volt" coil, field coils, to the negative main. The resistance of the "no volt" coil is of such a low value when compared with the resistance of the shunt field that it makes very little difference to the current strength in that field. If the supply fails, or the main switch is pulled off, the "no volt" coil is de-energised and releases the contact arm, which flies to the "off position" and thus disconnects the motor from the mains.

If the current exceeds a predetermined value the armature of the overload coil (which carries the main current or part of the main current) is attracted, thereby closing a contact which short-circuits the "no volt" coil, and thus the contact arm is released and made to break the circuit.

CONTROL GEAR.—ALTERNATING CURRENT MOTORS.

Single-phase A.C. Motors are provided with a double pole switch, cut-outs and a change-over switch which, in the starting position, connects a resistance in the running phase and a choke coil in the starting phase, and in the running position connects the running phase direct to the mains.

Where a wound rotor is used, a rotary type 3-circuit rheostat is used to provide for the insertion of resistance in the rotor circuits during starting, and in this case it is usual to arrange for additional contacts on this switch to make the necessary changes in the stator connections also.

Two-phase and Three-phase Motors are provided with a four or three pole switch, and four or three single pole cut-outs respectively.

Two and three-phase squirrel cage motors are started by a throw-over switch which, in the starting position, connects the stator in series with a resistance to the mains, and in the running position connects the stator direct to the mains. Sometimes a special star-delta switch is used, which connects the stator windings in star (or series) in the starting position and in delta (or parallel) in the running position.

Two and three-phase induction motors with wound rotors are provided with four or three pole switches and cut-outs respectively, which, when closed, connect the stator direct to the supply mains.

The rotor is connected in series with a resistance as shown in Fig. 21, which illustrates a three-phase motor. When the three contact arms, which are rigidly coupled to one spindle, are rotated, resistance is cut out of each phase step by step until at the "full on" position the rotor is short-circuited. The contact arm is held in position by a latch, which is controlled by a "no volt" coil connected across one phase of the supply.

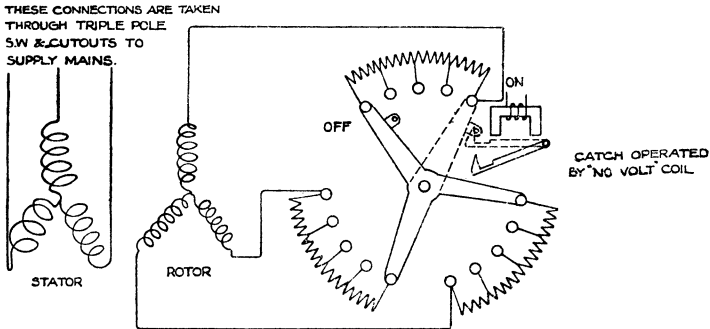

Fig. 21.

GENERATOR SWITCH GEAR.

For connecting the Generator to either of two batteries a double pole change-over switch is provided, similar to the knife switches already described, but having two positions. These switches may be of the slow break type, *i.e.*, they are not provided with the auxiliary spring-controlled blade, and they are not protected by an iron cover because the voltage is low.

An overload and reverse current circuit breaker is also provided between the Generator and the Battery, as described below.

CIRCUIT BREAKERS.

A circuit breaker for this purpose is a specially designed switch which is opened automatically by the action of one or more electromagnets.

The conditions required for battery-charging circuits are

- (1) that the breaker shall open if the current exceeds a predetermined safe value (accomplished by the overload coil);
- (2) that the breaker shall open if the current should flow from the battery against the direction of the generator E.M.F. (accomplished by the reverse coil).

Note.—The diagrams and description which follow are made purely theoretical for the sake of simplicity.

Construction and Operation of Combined Overload and Reverse Circuit Breaker (Figs. 22 to 24).—The main contacts consist of a

heavy brush of laminated copper. The auxiliary contacts, which make first and break last, prevent sparking occurring at the main contacts. The latter require lubrication with a little vaseline. The breaker is closed by hand and held closed by the trigger.

Overload Trip.—The sketch indicates clearly how the overload trip-coil, which carries the full current, can release the

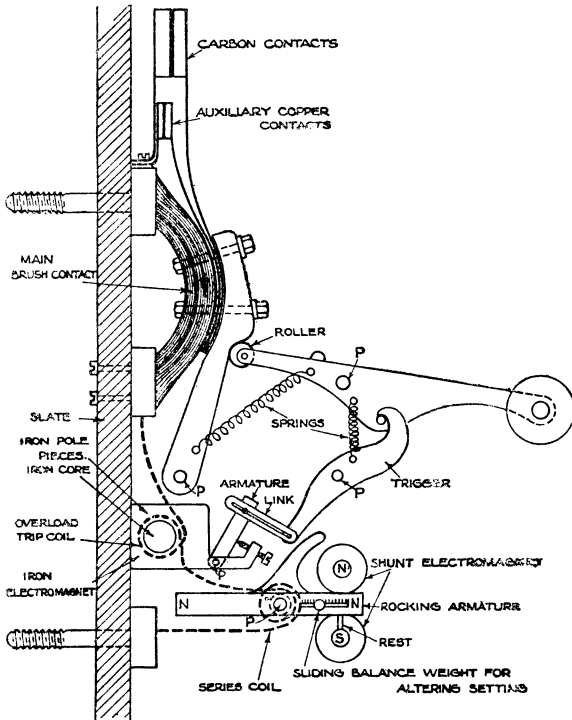

THEORETICAL DIAGRAM OF OVERLOAD & REVERSE CIRCUIT BREAKER.

ALL POINTS LETTERED 'P' ARE FIXED PIVOTS. THE RIGID FRAME CARRYING THESE PIVOTS HAS BEEN OMITTED FOR CLEARNESS

Fig. 22.

trigger and cause the breaker to open on overload. The actual value of overload is fixed by the nearness of the armature, which rests against an adjustable set screw.

Reverse Trip.—The Rocking Armature N N is pivoted at P (see Fig. 23). The series coil carries the full current of the

breaker. The two shunt electromagnets (only one is shown in Fig. 23) are connected in series across the generator, and the ends of their cores have a definite polarity permanently. With current flowing in the correct direction the polarity of the rock-

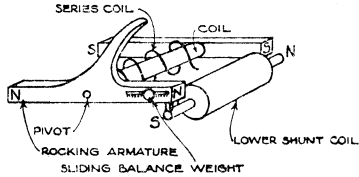

Fig. 23.

ing armature will be as shown in Fig. 23, and the rocking armature will be held down against the rest shown attached to the core of the lower shunt coil.

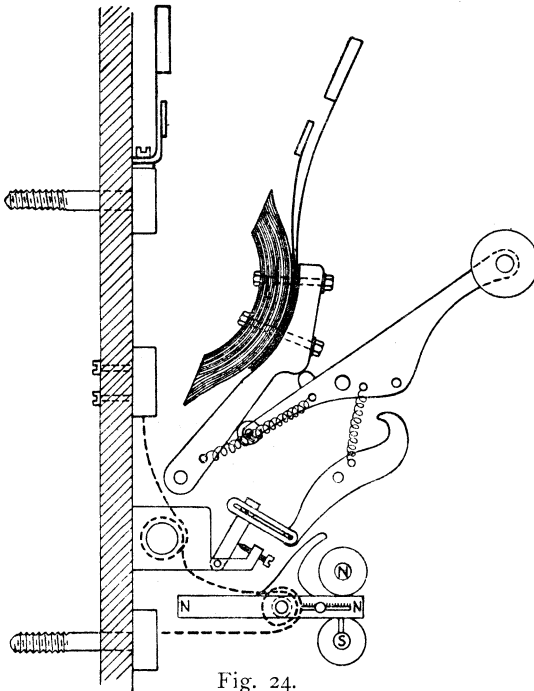

Fig. 24.

If the current in the series coil reverses, the polarity of the rocking armature reverses and its right hand end moves up, releases the trigger, and opens the breaker (Fig. 24).

The magnitude of the reverse current required to rock this armature up can be fixed by adjusting the position of the sliding balance weight.

Fig. 25 indicates an arrangement in which a separate relay is used to control the circuit breaker on reverse current. The relay is polarized and its action is fairly clear from the diagram. Its function is merely to close the circuit of the trip coil, the latter being a shunt coil fixed on the circuit breaker in a position in which it can release the trigger as soon as it is energised by current taken from the battery or generator. A separate relay has been much used in telephone exchanges because it is more sensitive and more reliable in action than a combined

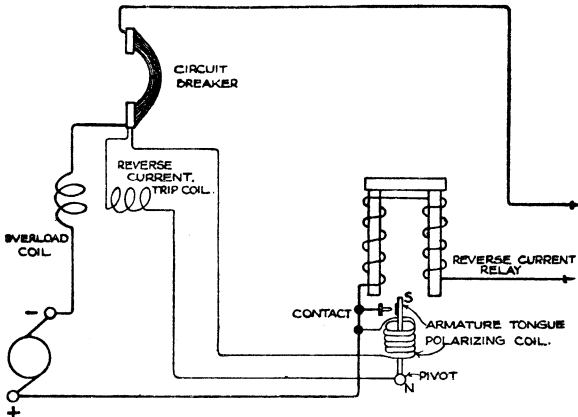

Fig. 25.

overload and reverse current breaker. Some of the so-called overload and reverse circuit breakers on the market are not sensitive enough to open even when a reverse current, strong enough to run the generator as a motor, is flowing from the battery.

Another type of relay for this purpose, Fig. 26, is similar in action to a moving coil ammeter whose pointer is made to touch a fixed contact screw in each of its two extreme positions. When the pointer closes either contact, it closes the trip coil of the circuit breaker, and this releases the trigger and causes the breaker to open. The relay shown is set to open circuit at 125 amps. (25 per cent. above the full load of 100 amps.), or at 5 amps. reverse current.

RINGERS.

Ringers for small Exchanges usually consist of a magneto generator driven by means of a belt from a small electric motor.

In larger Exchanges, where provision for "tone" signals, "busy back," etc., has to be made, ringing machines of a different type are used.

These machines consist of a motor driven from either the power supply or from the Exchange Battery coupled direct or by means of a belt to a generator fitted with slip rings at one end of its armature and a commutator at the other.

In some cases a dynamotor is used instead of the motor generator for supplying ringing currents. This is a motor and generator combined in one machine, the same field magnets serving for both. The armature has two separate sets of windings, one for the motor connected to a commutator at one

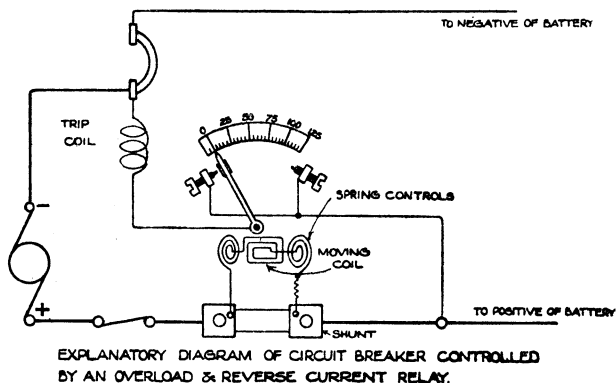

Fig. 26.

end of the shaft, and the other for the generator connected to slip rings at the other.

The current from the commutator is employed for exciting the field magnets of the generator. An alternating current at a periodicity of $16\frac{2}{3}$ cycles per second is generated by these machines. In addition to the slip rings an interrupter drum is fitted which produces interruptions at the rate of about 33, 133 and 400 per second respectively, in the circuits of which

they form part, for the purpose of "tone" signals. On the end of the shaft a worm is fitted which drives a worm-wheel carrying a spindle at right angles to the generator shaft. This spindle revolves once in six seconds and is fitted with a number of slip and interrupter rings which provide the various tone cycles. The present standard tone arrangements for both manual and automatic exchange systems are as follows :—

Varieties of Tone.	Frequency per second.	Tone Cycle applied.	Where used.
Dialling Tone ..	33	Continuous note	Automatic Exchanges
Ringing Tone ..	133 Superimposed on ringing frequency.	0.4 sec. on 0.2 sec. off 0.4 sec. on 2.0 secs. off	Automatic Exchanges and Manual Exchanges in C.C.I. areas.
Busy Tone ..	400	0.75 sec. on 0.75 sec. off	Automatic and Manual Exchanges
Number unobtainable Tone ..	400	Continuous note	Automatic Exchanges
Out of order Tone.	400	Continuous note	Manual Exchanges
Engaged on Trunk Tone	133	Continuous note	Manual Exchanges
Order Wire Tone..	400	Continuous note	Manual Exchanges

In addition to the tone cycles indicated in the above table, the low speed drum provides lamp flash, 0.75 sec. on and 0.75 sec. off, for automatic exchanges and interrupts the ringing current in the following cycle :—0.4 sec. on, 0.2 sec. off, 0.4 sec. on, 2.0 secs. off.

Ringing Vibrator No. 1.—In small Exchanges where the load is too great for hand generators, and yet does not justify a power-driven ringer, or where a power supply is not available,

ringing vibrators operated from primary cells are fitted. These cannot provide the busy-back, lamp flashing, machine ringing, etc., facilities.

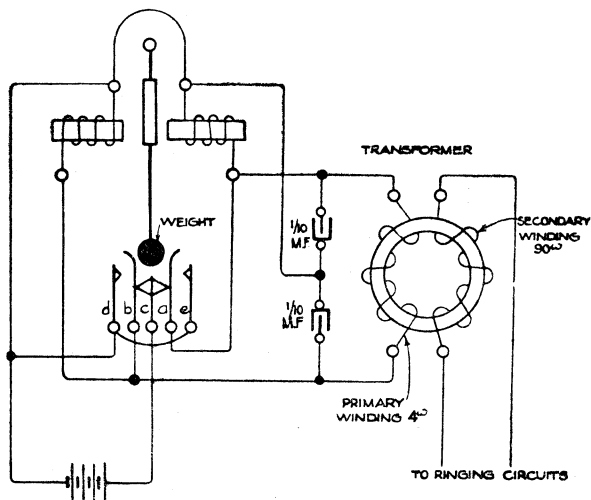
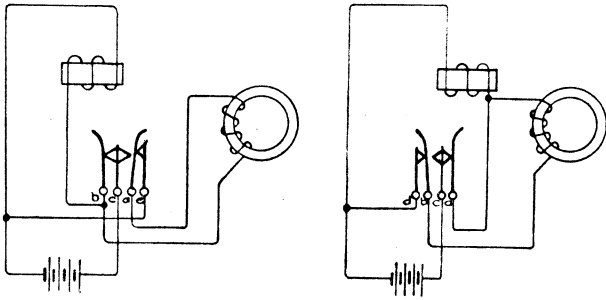

Fig. 27.

The connections of such a vibrator are shown in Fig. 27. It consists of an armature pivoted between the poles of two electromagnets. A heavy weight is fitted to this armature to give it a slow rate of vibration. The weight is hung between two contact springs *a* and *b* which, when the vibrator is not in use, rest against the centre contact *C*.

When the current is switched on by a relay in the battery circuit, the armature is attracted to one or other of the electromagnets, both of which are energised, because one electromagnet is slightly nearer the armature than the other. Assuming it moves to the right (Fig. 28), a current flows from the battery spring *c*, spring *b*, where it splits, part going through primary of transformer, spring *a*, spring *e*, back to the battery, and part going through the left-hand electromagnet back to the battery. The armature then moves to the left, and the connections become as shown in Fig. 29. A current flows from the battery, spring *c* to spring *a*, where it splits, part going

through the primary of the transformer (in the reverse direction to the previous case), spring *b*, spring *d*, back to the battery, and the other part through the right-hand coil back to



Figs. 28 and 29.

the battery. The armature again moves to the right and the cycle is repeated. By this means the direction of the current is reversed in the primary of the transformer each time the armature moves. The E.M.F. induced in the secondary winding is much higher than that applied to the primary, because the number of turns on the secondary is much greater than that on the primary. The secondary coil supplies a form of alternating current to the Exchange ringing circuits.

The condensers are placed across each electromagnet to prevent sparking at the contacts of the vibrator.

Fig. 30 shows the connections of Vibrator No. 2A and 3A. The operation of these vibrators is the same in principle as that of the Vibrator No. 1.

VIBRATORS RINGING No. 2A (Primary Battery Working) VIBRATORS RINGING No. 3A (Secondary Cell Working)

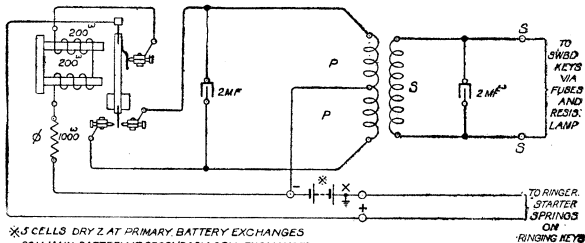

* 5 CELLS DRY Z AT PRIMARY BATTERY EXCHANGES
Z 22 V MAIN BATTERY AT SECONDARY CELL EXCHANGES
Ø OMITTED FROM VIBRATORS RINGING No 2A
X, EARTH OMITTED WHEN PRIMARY BATTERY IS USED

Fig. 30.

=====
LIST OF
Technical Pamphlets for Workmen

(Continued.)

GROUP E.

1. Automatic Telephony. Step by Step Systems.
2. Automatic Telephony. Coder Call Indicator (C.C.I.) Working.
3. Automatic Telephony. Keysending "B" positions.

GROUP F.

1. Subscribers' Apparatus C.B.
2. Subscribers' Apparatus C.B.S. Part I—C.B.S. No. 1 System.
3. Subscribers' Apparatus Magneto.
4. Private Branch Exchange—C.B.
5. Private Branch Exchange—C.B. Multiple, No. 9.
6. Private Branch Exchange—Magneto.
7. House Telephones.
8. Wiring of Subscribers' Premises.

GROUP G.

1. Secondary Cells, Maintenance of.
2. Power Plant for Telegraph and Telephone Purposes.
3. Maintenance of Power Plant for Telegraph and Telephone Purposes.
4. Telegraph Battery Power Distribution Boards.

GROUP H.

1. Open Line Construction, Part I.
2. Open Line Construction, Part II.
3. Open Line Maintenance.
4. Underground Construction, Part I.
5. Underground Construction, Part II.
6. Underground Maintenance.
7. Cable Balancing.
8. Power Circuit Guarding.
9. Electrolytic Action on Cable Sheaths, etc.
10. Constants of Conductors used for Telegraph and Telephone Purposes.

GROUP I.

1. Submarine Cables.

GROUP K.

1. Electric Lighting.
2. Lifts.
3. Heating Systems.
4. Pneumatic Tube Systems.
5. Gas and Petrol Engines.